

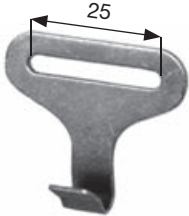

185.S.GM.20

**SQUADRETTA DI ARRESTO zincata con gommino**  
*ANGLE STOP – galvanized – with plastic stopper*



185.G.TA.20

**GANCIO TERMINALE D'ATTACCO zincato**  
*UPPER HOOK – galvanized*

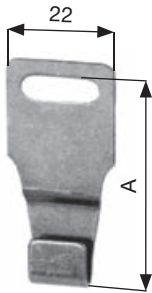

185.G.FS.20

**GANCIO FISSO di collegamento zincato**  
"A" = 42,2 mm  
*connecting FIXING HOOK – galvanized*  
"A"=42,2 mm

185.G.FS.22

**GANCIO FISSO di collegamento zincato**  
"A" = 41,5 mm  
*connecting FIXING HOOK – galvanized*  
"A"=41,5 mm



185.G.FD.20

**FIBBIA DI GANCIO DISTANZIABILE zincato**  
*CONNECTING-SPACER HOOK – galvanized*



185.G.MD.20

**MAGLIETTA DI GANCIO DISTANZIABILE zincato**  
*LINK FOR CONNECTING-SPACER HOOK galvanized*



185.G.PB.20

**PIASTRINA PER BALZA - zincata**  
*LOWER HOOK galvanized*



185.C.00.22

**CATENACCIOLO DI SICUREZZA tropicalizzato – per tapparella in legno**  
*LOCKING BOLT- yellow galvanized-for wooden rolling shutter*

# GANCI PER RULLO METALLICO E AVVOLGIBILI IN PLASTICA

## HOOKS FOR METAL ROLLER AND PLASTIC ROLLING SHUTTERS



**186.G.2A.20**

**GANCIO TERMINALE DI ATTACCO a 2 asole - zincato**  
UPPER CONNECTING HOOK with 2 buttonholes - galvanized



**186.G.AA.20**

**GANCIO TERMINALE DI ATTACCO - asola antitaglio - zincato**  
UPPER CONNECTING HOOK with buttonhole cut resistant, - galvanized



**187.G.3A.20**

**GANCIO DI ATTACCO AL RULLO zincato**  
CONNECTING HOOK FOR METAL ROLLER - galvanized

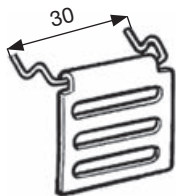

**187.G.FL.20**

**GANCIO PER RULLO A FILO zincato**  
HOOK FOR METAL ROLLER - galvanized



**188.G.00.20**

**GRAPPA DI FERMO CINTINO zincata**  
BELT FASTENER - galvanized



**190.C.AG.00**

**CINTINO CON ASOLA per aggancio telo**  
TAPE WITH BUTTONHOLE for hooking

## GUIDACINGHIA

### STRAP GUIDES

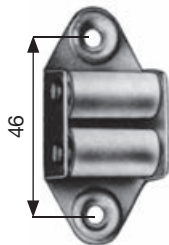

#### GUIDACINGHIA con rullini nylon

##### STRAP GUIDE with nylon rollers

**195.G.VP.20**

zincato / white galvanized

**195.G.VP.22**

ottonato / brass covered

**195.G.VP.37**

brunito / dark brown

#### GUIDACINGHIA con rullini ferro

##### STRAP GUIDE with iron rollers

**195.G.VF.20**

zincato / white galvanized

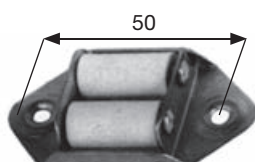

#### GUIDACINGHIA TRASVERSALE con rullini nylon

##### TRANSVERSAL STRAP GUIDE with nylon rollers

**196.G.TP.20**

zincato / white galvanized

**196.G.TP.22**

ottonato / brass covered

#### GUIDACINGHIA TRASVERSALE con rullini ferro

##### TRANSVERSAL STRAP GUIDE with iron rollers

**196.G.RT.20**

zincato / white galvanized

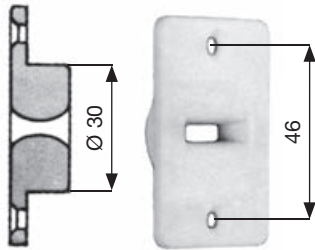

### GUIDACINGHIA NYLON ad incastro Ø 30 mm

NYLON STRAP GUIDE joint Ø 30 mm

<b>199.G.VI.93</b>	bianco / white
--------------------	----------------

<b>199.G.VI.94</b>	marrone / brown
--------------------	-----------------

<b>199.G.VI.95</b>	nero / black
--------------------	--------------

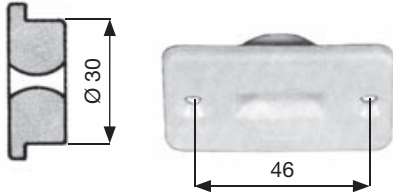

### GUIDACINGHIA NYLON TRASVERSALE ad incastro Ø 30 mm

NYLON STRAP GUIDE joint Ø 30 mm

<b>200.G.TI.93</b>	bianco / white
--------------------	----------------

<b>200.G.TI.94</b>	marrone / brown
--------------------	-----------------

<b>200.G.TI.95</b>	nero / black
--------------------	--------------

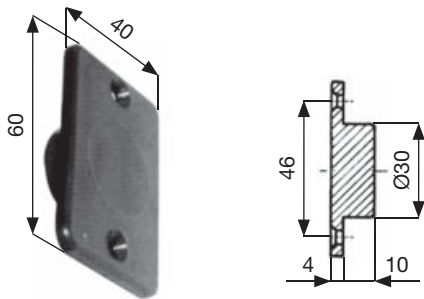

### TAPPO NYLON per foro guidacinghia

NYLON PLUG for strap guide hole

<b>200.T.PG.93</b>	bianco / white
--------------------	----------------

<b>200.T.PG.94</b>	marrone / brown
--------------------	-----------------

<b>200.T.PG.95</b>	nero / black
--------------------	--------------

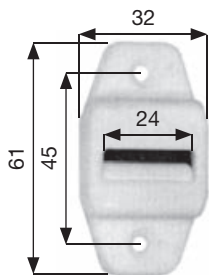

### GUIDACINGHIA NYLON Con spazzolino

NYLON STRAP GUIDE with brush

<b>204.G.SP.93</b>	bianco / white
--------------------	----------------

<b>204.G.SP.94</b>	marrone / brown
--------------------	-----------------

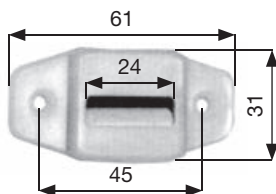

### GUIDACINGHIA NYLON TRASVERSALE

Con spazzolino

TRANSVERSAL NYLON STRAP GUIDE with brush

<b>204.T.SP.93</b>	bianco / white
--------------------	----------------

<b>204.T.SP.94</b>	marrone / brown
--------------------	-----------------

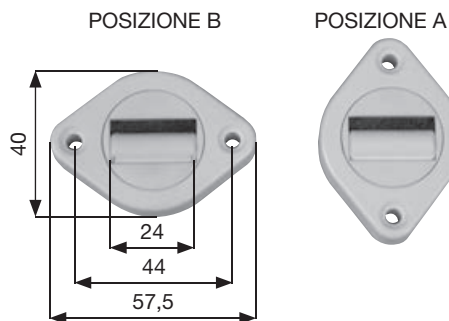

### GUIDACINGHIA NYLON GIREVOLE

2 posizioni con blocco - Con spazzolino

NYLON STRAP GUIDE -TURNING

2 POSITIONS with brush

<b>204.G.GI.93</b>	bianco / white
--------------------	----------------

<b>204.G.GI.94</b>	marrone / brown
--------------------	-----------------

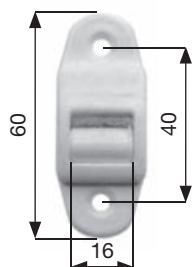

### GUIDACINGHIA NYLON CON SPAZZOLINO

per cintino 14 mm

NYLON STRAP GUIDE WITH BRUSH

for strap 14 mm

<b>250.G.SP.93</b>	bianco / white
--------------------	----------------

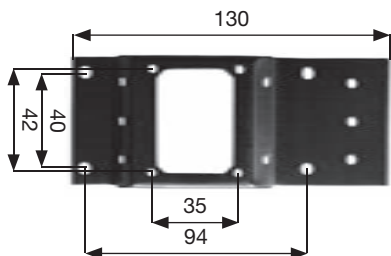

**204.S.00.20**

**SUPPORTO L.130 per guidacinghia a cassonetto - zincato**  
*SUPPORT L.130 for box strap guide-galvanized*

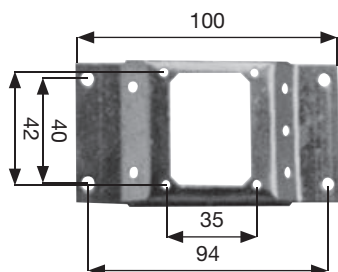

**204.S.C0.20**

**SUPPORTO L.100 per guidacinghia a cassonetto - zincato**  
*SUPPORT L.100 for box strap guide-galvanized*

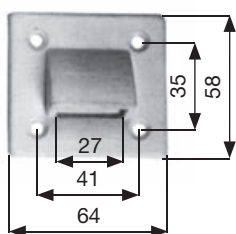

**204.G.00.90**

**GUIDACINGHIA NYLON per cassonetto prefabbricato - bianco**  
*BOX NYLON FRONTAL STRAP GUIDE - white*

## TAPPI D'ARRESTO PLASTIC STOPPER

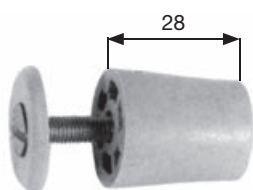

### TAPPO D'ARRESTO 28 mm Con vite e rondella PLASTIC STOPPER 28 mm

<b>205.T.28.91</b>	Avorio / <i>ivory</i>
<b>205.T.28.92</b>	Grigio / <i>grey</i>
<b>205.T.28.93</b>	Bianco / <i>white</i>
<b>205.T.28.94</b>	Douglas / <i>wood colour</i>
<b>205.T.28.95</b>	Nero / <i>black</i>
<b>205.T.28.96</b>	Testa di moro / <i>dark brown</i>
<b>205.T.28.97</b>	Verde / <i>green</i>
<b>205.T.28.99</b>	Ocra / <i>yellow ochre</i>

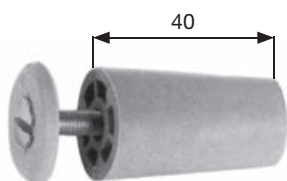

### TAPPO D'ARRESTO 40 mm Con vite e rondella PLASTIC STOPPER 40 mm

<b>205.T.40.91</b>	Avorio / <i>ivory</i>
<b>205.T.40.92</b>	Grigio / <i>grey</i>
<b>205.T.40.93</b>	Bianco / <i>white</i>
<b>205.T.40.94</b>	Douglas / <i>wood colour</i>
<b>205.T.40.95</b>	Nero / <i>black</i>
<b>205.T.40.96</b>	Testa di moro / <i>dark brown</i>
<b>205.T.40.97</b>	Verde / <i>green</i>
<b>205.T.40.99</b>	Ocra / <i>yellow ochre</i>

# CATENACCIOLI DI SICUREZZA

## SECURITY LOCKING BOLTS



### CATENACCIOLI LATERALI A SCATTO (1 paio)

LATERAL SECURITY LOCKING BOLTS (1 pair)

**210.C.LS.20** Zincati / galvanized

**210.C.LS.37** Bruniti / burnished

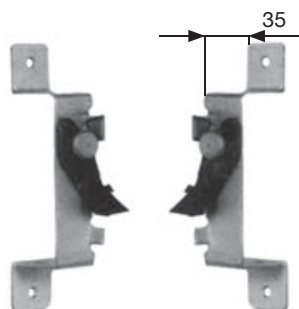

### CATENACCIOLI LATERALI A SCATTO PER TELAI A SPORGERE (1 paio)

LATERAL SECURITY LOCKING BOLTS for projector frame (1 pair)

**212.C.SP.20** Zincati / galvanized

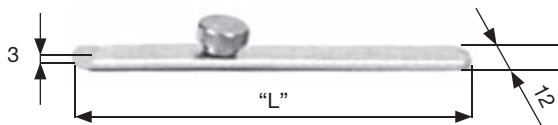

### CATENACCIOLO PER BALZA ALLUMINIO con pomello di bloccaggio

LOCKING BOLT WITH LOCKING- POMMEL FOR ALUMINIUM END SLAT

**214.C.12.20** L= 125 Zincato - galvanized

**214.C.80.20** L= 80 Zincato - galvanized

**214.C.AL.20** L= 120 Zincato - galvanized



### CATENACCIOLO PER BALZA ALLUMINIO

LOCKING BOLT FOR ALUMINIUM END SLAT

**214.C.AB.20** L=150 mm      **214.C.B1.20** L=1000 mm

**214.C.B3.20** L=350 mm      **214.C.B2.20** L=1200 mm

**214.C.B6.20** L=600 mm      **214.C.B5.20** L=1600 mm

**214.C.B8.20** L=800 mm

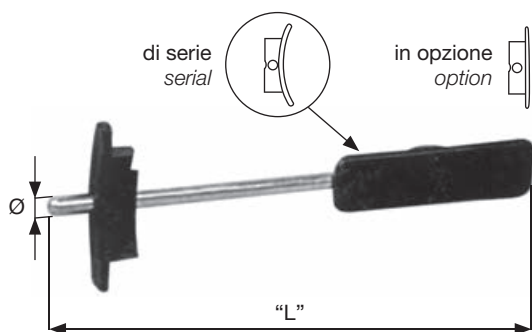

### CATENACCIOLO PER STECCA ALLUMINIO

LOCKING BOLT FOR ALUMINIUM SLAT

**215.C.A6.20** Ø 6-L= 170 mm      **215.C.AS.20** Ø 7-L= 170 mm

**215.C.S6.20** Ø 6-L= 600 mm      **215.C.S7.20** Ø 7-L= 600 mm

**215.C.S3.20** Ø 6-L= 800 mm      **215.C.S8.20** Ø 7-L= 800 mm

**215.C.S4.20** Ø 6-L= 1000 mm      **215.C.S9.20** Ø 7-L= 1000 mm

**215.C.SL.20** Ø 6-L=>1000 mm      **215.C.7L.20** Ø 7-L=>1000 mm

## MOLLE DI SICUREZZA SAFETY SPRINGS

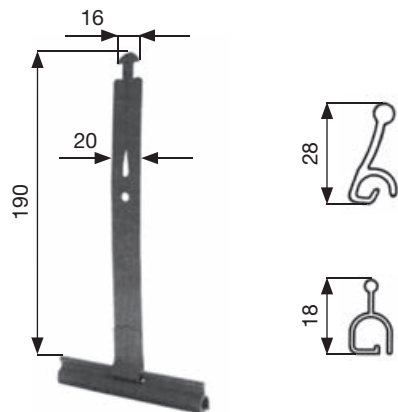

**216.M.G3.30** MOLLA DI SICUREZZA per stecca 14 mm  
SAFETY SPRING for slat 14 mm

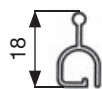

**216.M.J3.30** MOLLA DI SICUREZZA per stecca 14 mm  
SAFETY SPRING for slat 14 mm

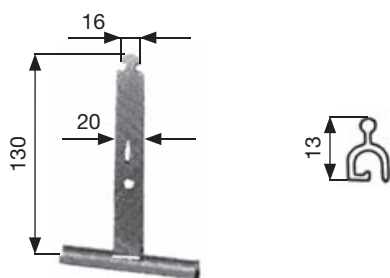

**216.M.P0.30** MOLLA DI SICUREZZA per stecca 9 mm  
SAFETY SPRING for slat 9 mm

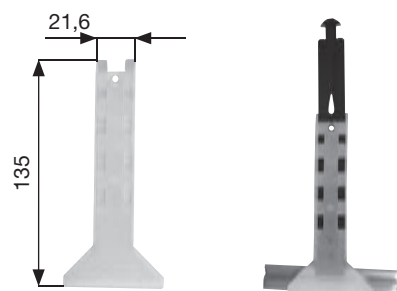

**216.P.00.90** PROTEZIONE IN PVC per molla di sicurezza  
PVC PROTECTION for safety spring

Immagine esemplificativa di protezione applicata su molla

## RULLI DI RINVIO GLIDE ROLLERS

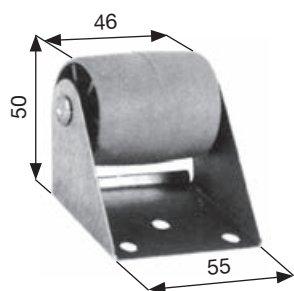

**220.R.50.20** RULLINO DI RINVIO tipo MEDIO  
Medium GLIDE ROLLER

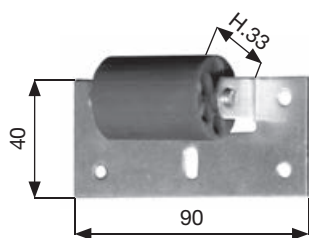

**220.R.B3.20** RULLINO DI RINVIO tipo BLS (h.33)  
GLIDE ROLLER

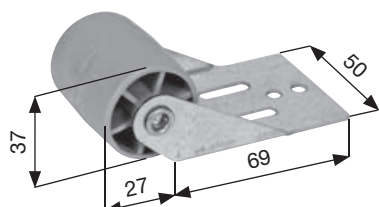

**220.R.R5.20** RULLINO DI RINVIO REGISTRABILE  
ADJUSTABLE GLIDE ROLLER

# DISPOSITIVI DI SICUREZZA

## SECURITY DEVICES

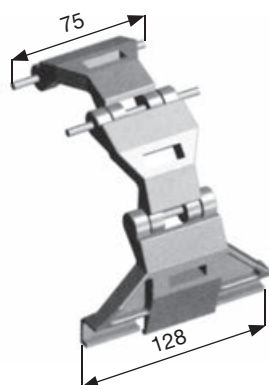
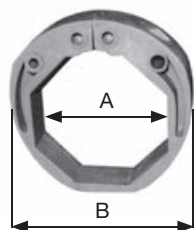
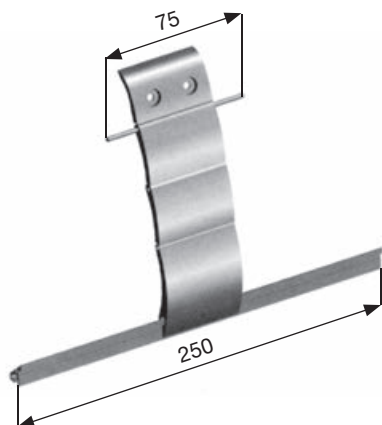
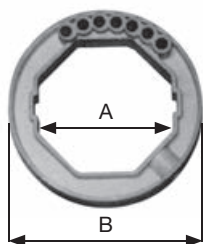

### ADATTATORE PER "EUROBLOCK"

#### ADAPTER RING "EUROBLOCK"

<b>475.A.00.90</b>	Per rullo Ø 60 mm (A) for roller Ø 60 mm	B = 88 mm
<b>475.A.40.90</b>	Per rullo Ø 40 mm (A) for roller Ø 40 mm	B = 69 mm
<b>475.A.70.90</b>	Per rullo Ø 70 mm (A) for roller Ø 70 mm	B = 104 mm

### "EUROBLOCK"

<b>475.S.2E.90</b>	2 elementi/ 2 links	Per stecca 14 mm For slat 14 mm
<b>475.S.3E.90</b>	3 elementi/ 3 links	
<b>475.S.M2.90</b>	2 elementi/ 2 links	Per stecca 9 mm For slat 9 mm
<b>475.S.M3.90</b>	3 elementi/ 3 links	

### ADATTATORE PER "SUPERBLOCK"

#### ADAPTER RING "SUPERBLOCK"

<b>477.A.S6.90</b>	Per rullo Ø 60 mm (A) for roller Ø 60 mm	B = 80 mm
<b>477.A.S7.90</b>	Per rullo Ø 70 mm (A) for roller Ø 70 mm	B = 90 mm

### "SUPERBLOCK"

<b>477.S.N2.90</b>	2 elementi/ 2 links	Per stecca 14 mm For slat 14 mm
<b>477.S.N3.90</b>	3 elementi/ 3 links	
<b>477.S.M2.90</b>	2 elementi/ 2 links	Per stecca 9 mm For slat 9 mm
<b>477.S.M3.90</b>	3 elementi/ 3 links	

### "UNIBLOCK" Molle di aggancio rapido sul rullo – profilo intercambiabile di aggancio su stecca da 14 mm e 9 mm

Fast coupling on the roller - dual hook  
for slat 14 mm and 9 mm

<b>479.U.20.90</b>	2 elementi/ 2 links
<b>479.U.30.90</b>	3 elementi/ 3 links